

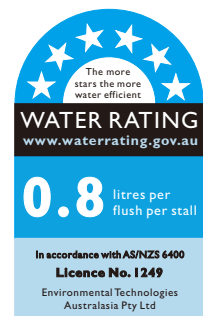

# INSTALLATION INSTRUCTIONS

**ET3-M Smart Demand Urinal Flushing System**  
**- urine detecting sensor fixed to rear of ceramic**  
**for fully hands free 6 star WELS electronic activation.**

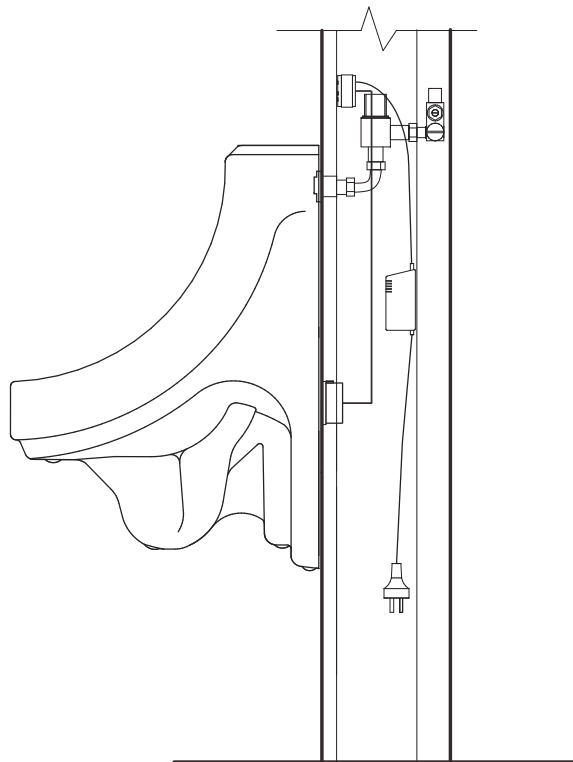

**Thank you for purchasing this Enviro-Tech product**

# INSTALLATION INSTRUCTIONS ET3-M URINAL FLUSH VALVE

## TECHNICAL SPECIFICATION

Smart Demand - Urine sensing technology. Product will not detect movement in room, heat, light or any other method of activation.

Function	ET3-M
Power input	DC: 6V (4XAA alkaline batteries) AC: 220-240V (50/60Hz)
Power consumption	Static: <4Ma; active: <500mA
Water pressure	100kPa-500kPa Maximum (recommended 350kPa)
Inlet/outlet diameter	15mm 1/2G
Flush volume	Pre-set at 800mls at 350kPa
Inductive confirmation times	Detects constant flow over sensor - 6 times in 5 seconds before flushing
Confirmation time after use	5 seconds
Flush time	4 seconds
Reset time after flush	10-20 seconds
Automatic Stadium Mode	Increases confirmation time and flushes less often in times of high usage
Trap seal protection	Automatic every 24hrs if not used

**IMPORTANT-** Product is designed to operate as mains powered with battery back-up. If only batteries are installed, product will function but batteries will run down quickly and Urinal will suddenly stop working. Surge protectors are recommended to avoid power spikes affecting the life of the transformer and the Controller. Transformers should not be plugged in until all major electrical work has been completed on site. Ensure good access to components for maintenance.

## COMPONENTS

1. Solenoid valve

2. DC Battery box

3. Sensor box

4. Control panel box

5. Transformer

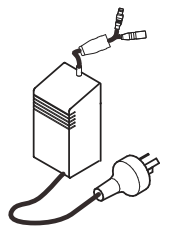
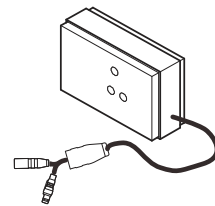
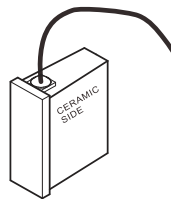
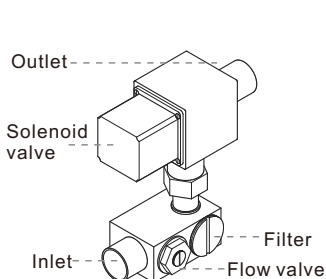

# INSTALLATION

We strongly recommend that you use a qualified and registered plumber and electrician. You must ensure all pipe work is flushed thoroughly, particularly in new builds or where lines have been disrupted. Solenoid valves are particularly susceptible to debris and will require more thorough flushing than a standard plumbing fixture. We also recommend the install of a 1/2" Y strainer as additional filter protection against poor water quality. Water pressure of more than 500kPa will damage solenoid.

1. Placement of sensor is vital to ensure correct product function. Before hanging urinal on the wall, place sensor on lower rear of the urinal and tape in place ensuring 'ceramic side' is placed against urinal.

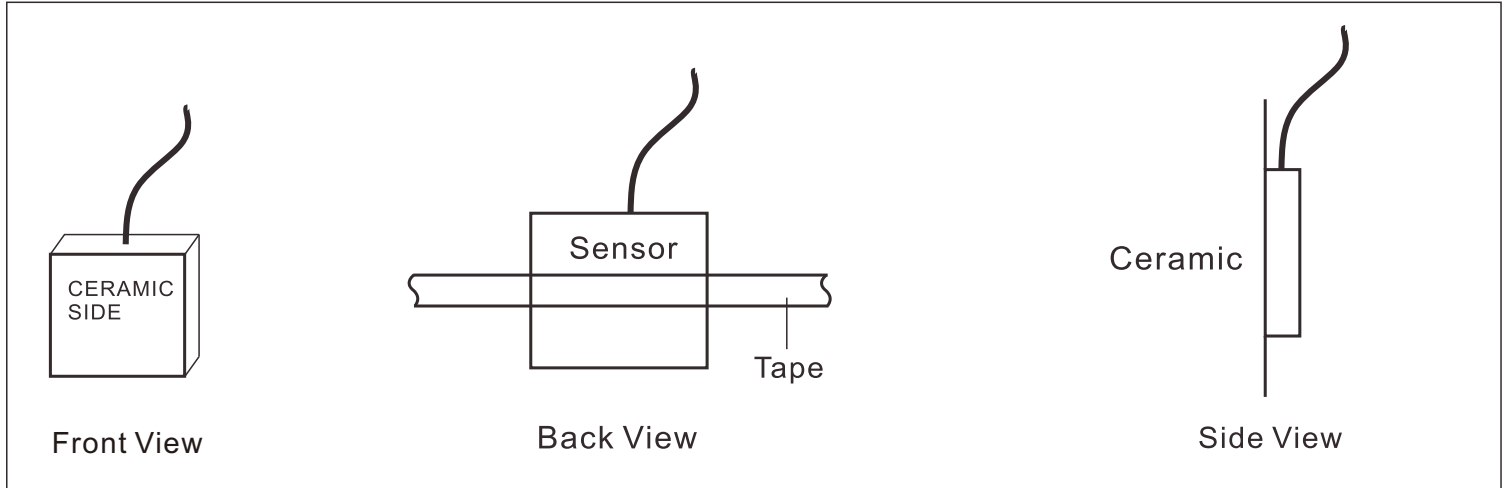

2. Lay out all other components, connect all cables in the correct order as per diagram. **WARNING: Electronics will be damaged if connected incorrectly and will not be covered by your warranty.**

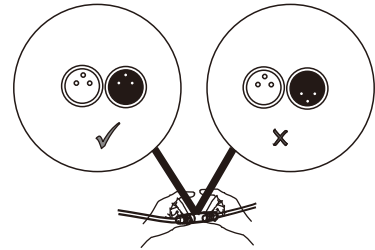
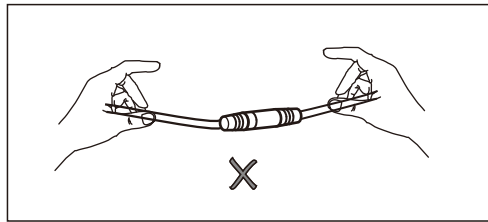
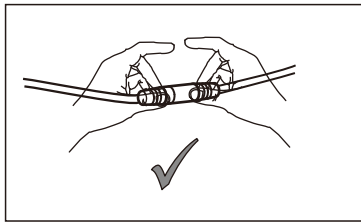

**Attention: Hold the plug not the wire to connect and disconnect and make sure pins align to the holes correctly.**

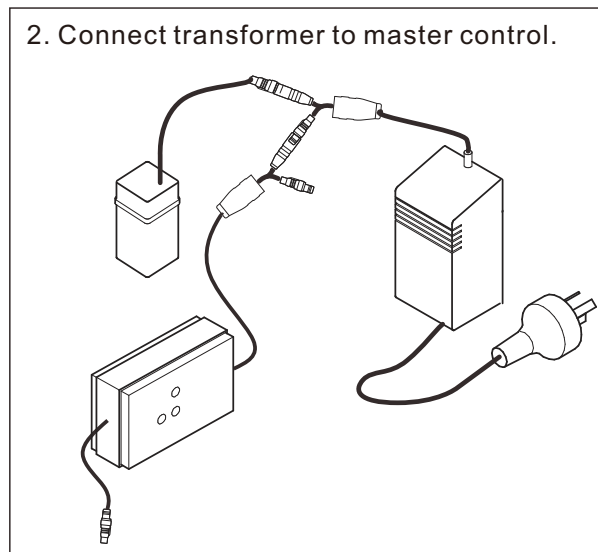
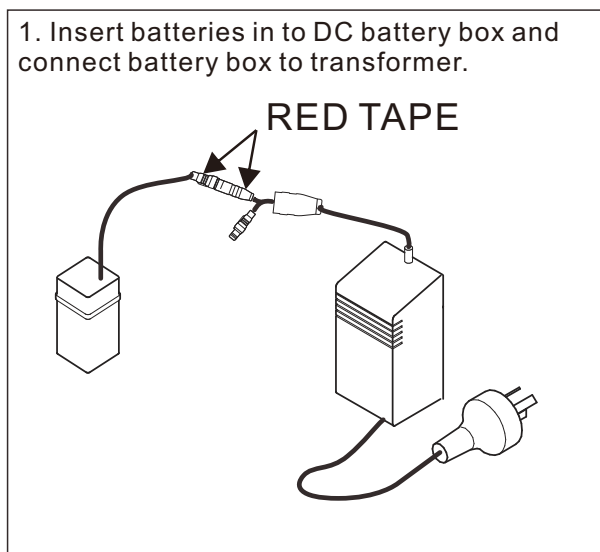

3. Connect master control to solenoid valve.

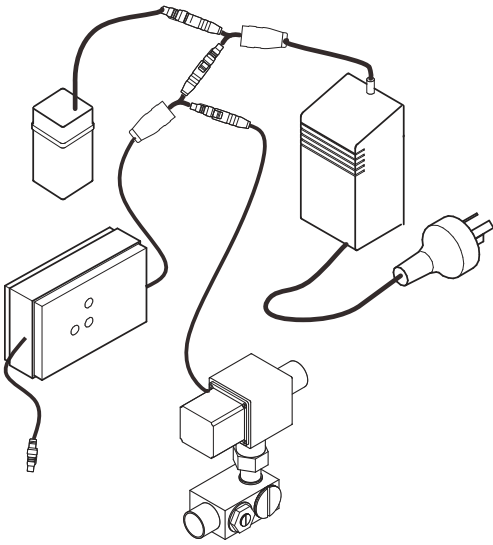

4. Connect sensor to master control. Make sure the raised ridge on the outside of each plug and the flat part of each plug matches together.

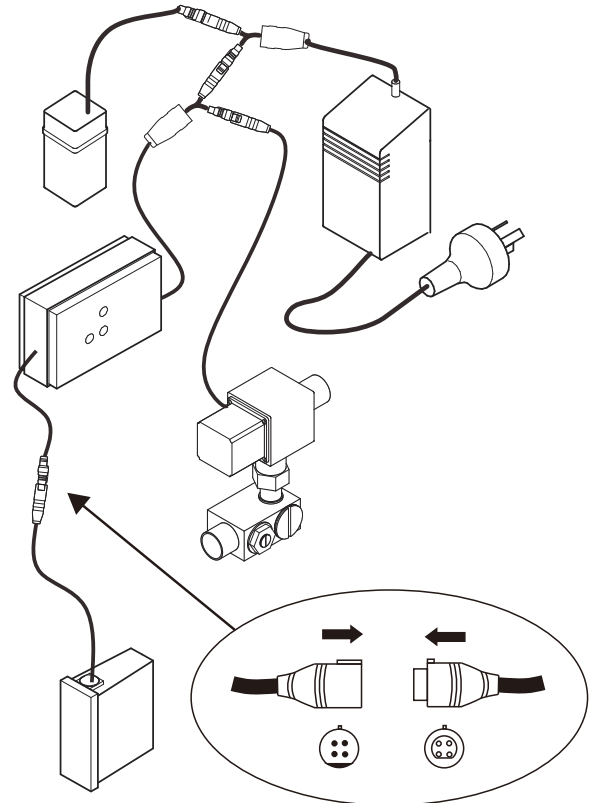

5. Connect transformer to power.  
**Confirm there is power at the socket.**

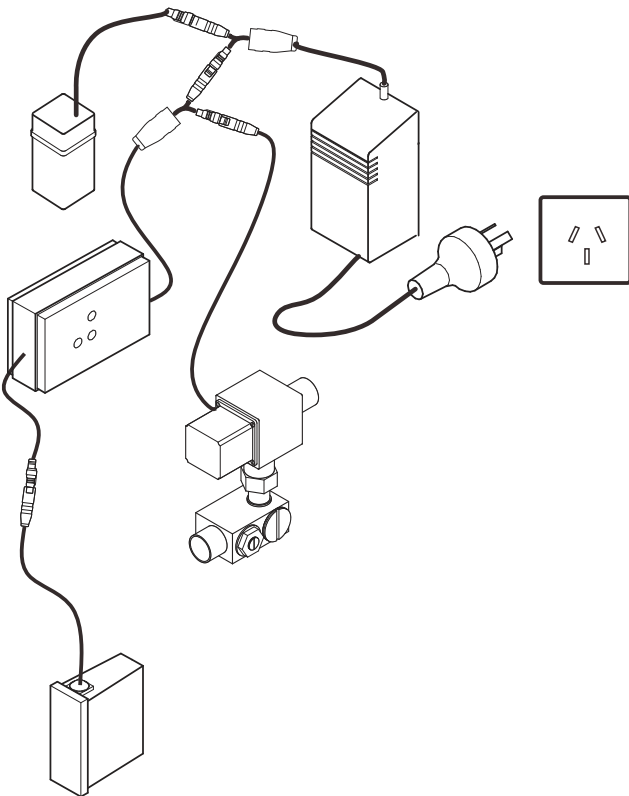

**3.** Test that the sensor is sited correctly by spraying/pouring water on the surface of the front of the urinal (must run over sensor location) for up to 20 seconds. There will be a red-light flashing on the controller, when you stop spraying/pouring water, the red light will stay on - there will be a delay, but the solenoid will activate; you may hear the solenoid click (simulates the flush).

**4.** Once you have confirmed that sensor is located correctly: Ensure application site is free of dust and grease. Silicone sensor in place. **Note – Attach using silicone around edge of the sensor only.** Ensure that silicone does not spread to sensing surface, as this will reduce sensitivity and compromise the effectiveness of product. Refer to the Installation diagrams for your installation:

## STANDARD IN-WALL INSTALLATION

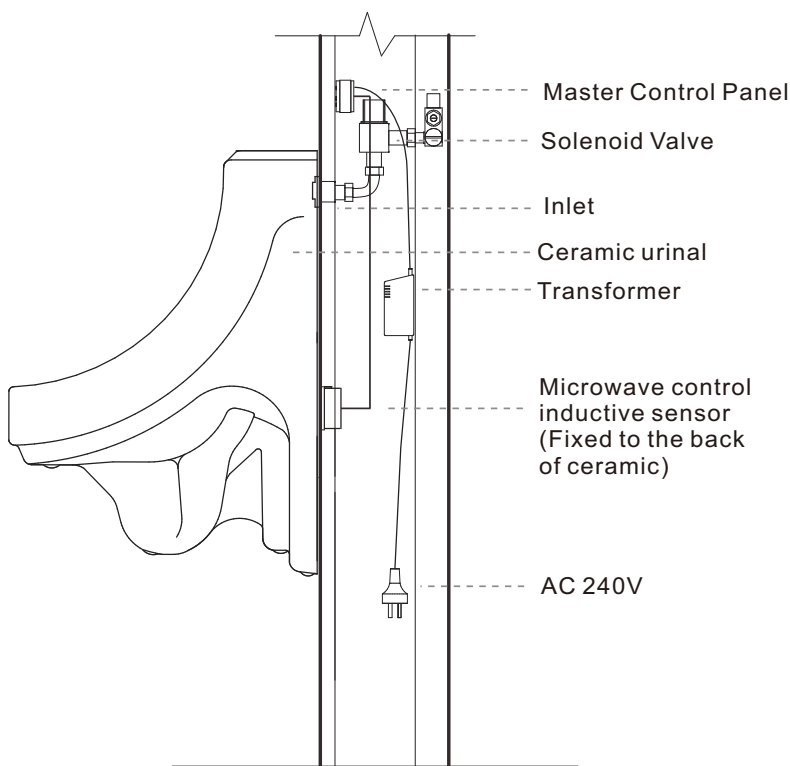

## INSTALLATION IN-CEILING

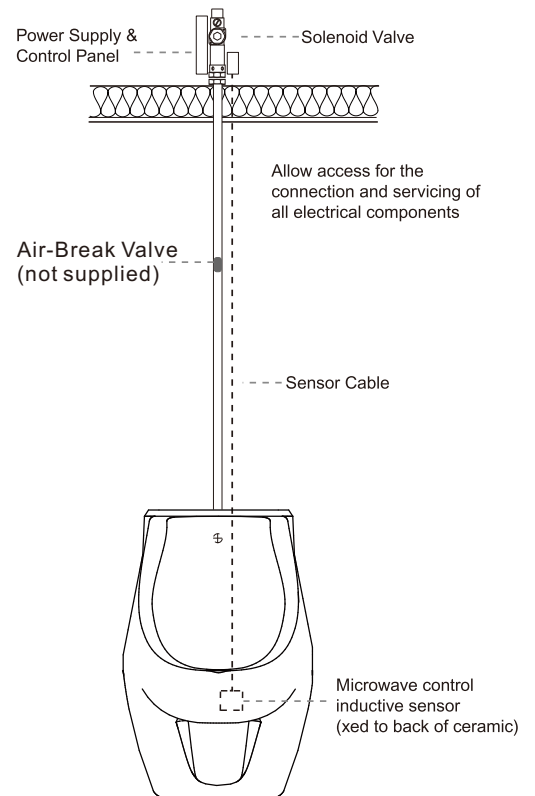

**IMPORTANT:** In-ceiling installation – Installation of air-break valve is recommended. Flush Valve must be installed vertically. Flushpipe must be vertical and straight. Use Copper pipe for flushpipe, DO NOT use flexi hose and ensure no bends/kinks or horizontal pipework. Incorrect installation WILL NOT be covered by your warranty.

# COMMISSIONING OF INSTALLATION

**Note:** When testing the urinal – note confirmation times from the Technical Specification table. Repeated rapid testing will cause product to enter Stadium Mode, resulting in intermittent flushing.

**Connection Test** – this will confirm that controller and solenoid are working correctly. It will confirm that there is power and that all connections are correct.

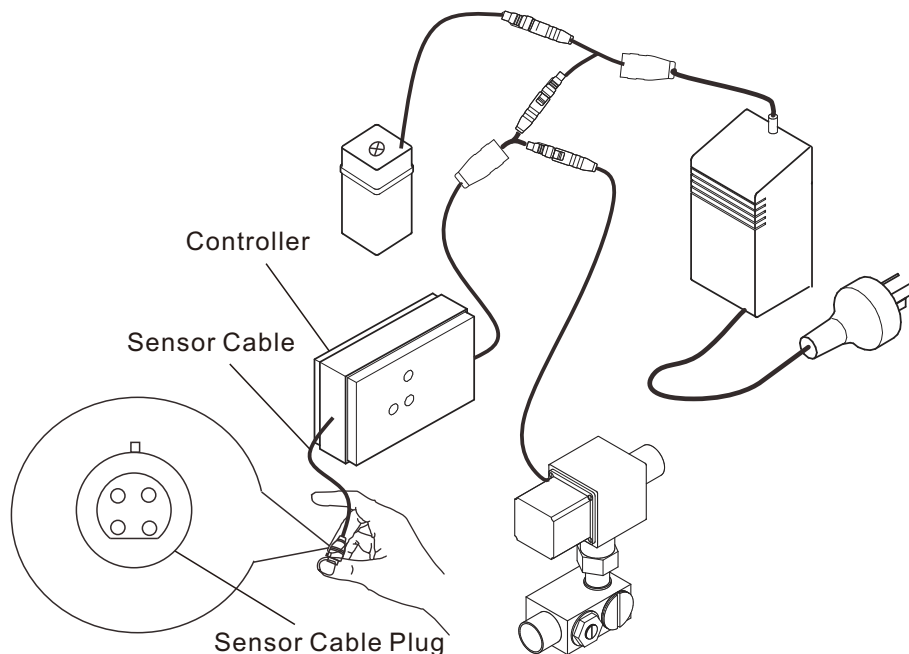

Unplug sensor cable and rub thumb over 4 metal pins. The red light will flash, stop rubbing pins after 20 seconds, the red light will stop flashing, the solenoid will be activated, and the urinal will flush.

**Sensor Test** - Make sure silicone is dry before performing flush test:

Spray water/pour water slowly over the surface of the urinal (must run over sensor location) for 20 seconds. The red light will be flashing, when you stop spraying/pouring water, the red light will stay on – there will be a delay, but the urinal will flush.

**Water Saving test** - Make sure silicone is dry before performing this test:

Spray/pour water over the surface of the urinal (in area where sensor is attached) and on flush activation, collect the water in a measuring jug. The volume of water collected should be less than 1ltr. If necessary, adjust volume using the flow valve adjuster, next to inlet valve on solenoid. (Note: Flush volume of 800mls is pre-set at the factory using 350kPa)

## SETTINGS

This 6 Sar WELS rated product is tested at 350kPa and is pre-set as follows:

Detection Zone – 250mm

Flush/Time/Volume – 4 second flush delivering 800mls per flush

If this volume is not adequate for your setting, adjustment should be made to the flow valve on the inlet valve on the solenoid. NB. Any adjustment may reduce the WELS rating for this product.

**DO NOT** attempt to make any adjustments to the controller. Product can be damaged and this is NOT covered by your product warranty.

## TROUBLE SHOOTING

Problem	Possible Cause	Solution
No water out	<p>Most common: Plugs not connected correctly/ No water supply/No power</p> <p>The filter or solenoid is blocked</p>	<ul style="list-style-type: none"> <li>• Check water and power supplies.</li> <li>• NB. If Urinal has been working correctly for some time but has suddenly stopped – likely cause is no power. Change Batteries and check mains power supply.</li> <li>• Unplug all cables, leave unplugged for 5 minutes and reconnect everything carefully in the correct order. (See Cable Connection diagrams)</li> <li>• Perform Connection and Sensor Tests. (See Commissioning of Installation Section)</li> <li>• If problem persists- call us for advice.</li> </ul> <p>Clean Filter. Clean/replace solenoid.</p>
Urinal will not flush	Commissioning Tests not completed correctly	Flush Valve is urine sensing. It does not detect movement in the room, heat, light or any other method of activation. Perform Connection and Sensor Tests. (See Commissioning of Installation Section)
Too much or too little water flow	<p>Water pressure is incorrect Flow valve needs adjusting The filter or solenoid is blocked</p>	<p>Adjust water pressure. Adjust flow valve on solenoid. Clean the filter. Clean/replace solenoid.</p>
Second Flush/Run On shortly after installation	<p>Incorrect installation method  Debris in Solenoid</p>	<p>Check installation is correct (See Installation Instructions) Run-on after install – usually caused by debris in water supply preventing solenoid closing. Can also be caused by high water pressure &gt;500kPa. Clean solenoid, flush pipework and retest. You may need to replace solenoid, which is not covered by product warranty.</p>

For detailed troubleshooting advice, see the Installation page of our websites [enviro-tech.com.au](http://enviro-tech.com.au) or [enviro-tech.co.nz](http://enviro-tech.co.nz)



### **WARRANTY**

This Enviro-Tech product is guaranteed for 12 months from the date of purchase. This is a parts only warranty and Enviro-Tech is not liable for any associated costs incurred in the replacement or repair of any item. For full details of the warranty conditions, see the Warranty page of our websites.

### **AFTERCARE**

Ensure good water quality is maintained and the filter on the solenoid valve is cleaned out regularly. Failure to do so could result in a blocked solenoid/impair product functionality and may invalidate your product warranty.

This Enviro-Tech product is manufactured strictly to adhere to the ISO9001 standard, WaterMark certification and WELS standards. Enviro-tech reserves the right to update product technology at any time.

#### Contact Info:

Australia – 1300 530 883 or [info@enviro-tech.com.au](mailto:info@enviro-tech.com.au)

New Zealand – 0800 2 ENVIRO or [info@enviro-tech.co.nz](mailto:info@enviro-tech.co.nz)